

200 MARCO SIMPLE

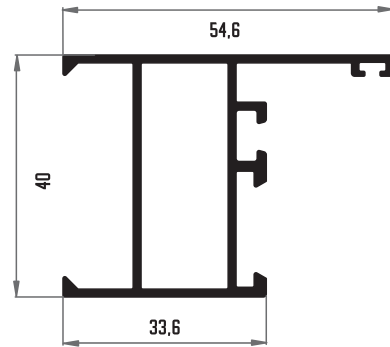

201 MARCO CON OREJAS

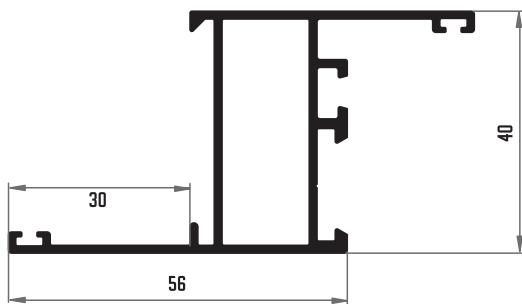

202 MARCO CON SOLAPE

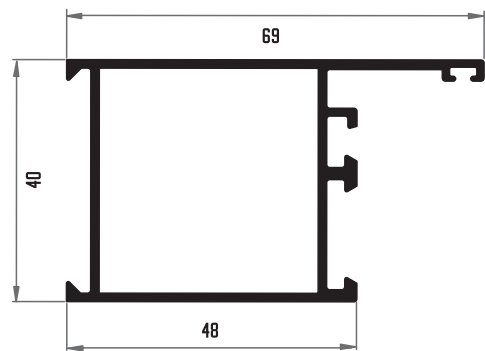

203 MARCO PORTADA

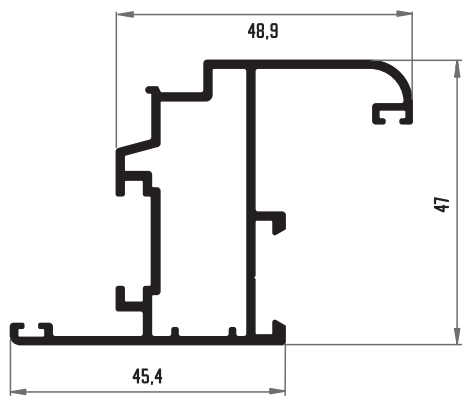

204 HOJA CURVA VENTANA

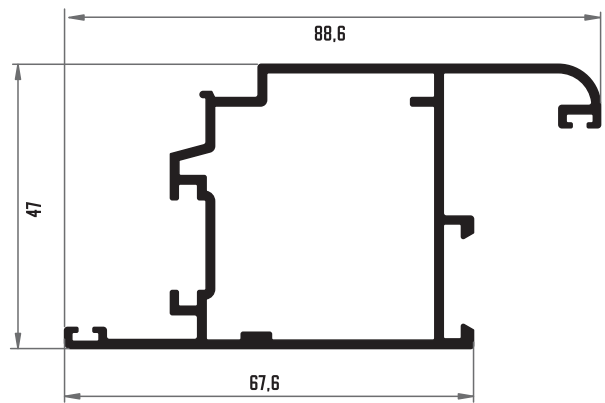

205 HOJA CURVA PORTADA

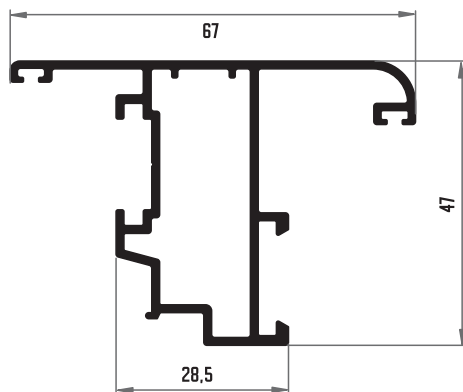

206 HOJA VENTANA APERTURA EXTERIOR

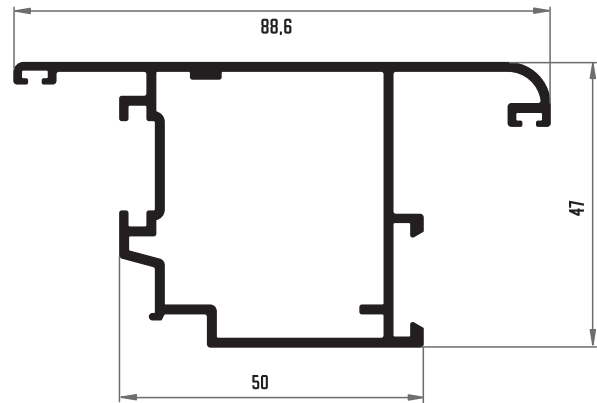

207 HOJA PORTADA APERTURA EXTERIOR

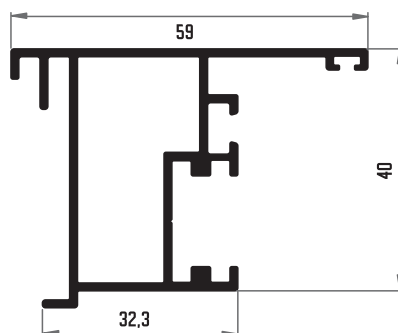

208 INVERSOR CENTRAL

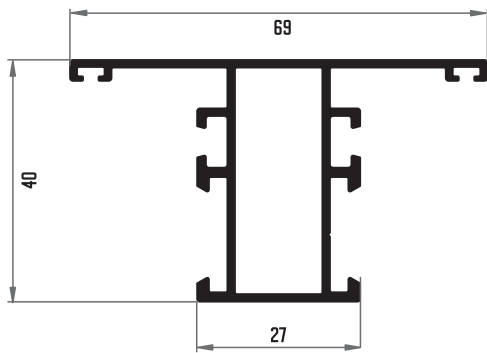

209 TRAVESAÑO VENTANA 69 MM

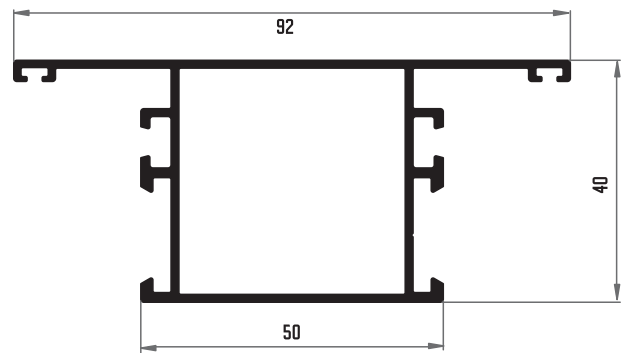

210 TRAVESAÑO PORTADA

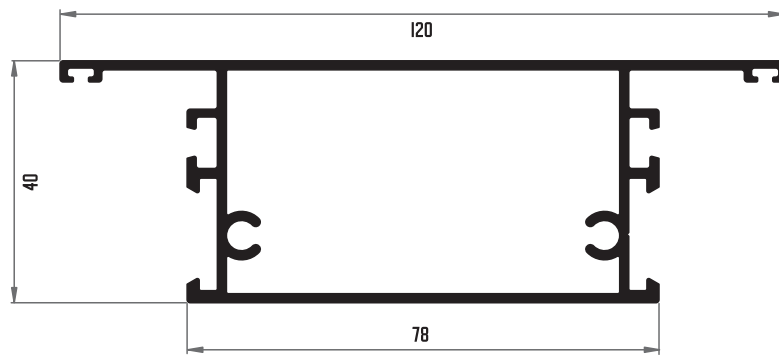

211 TRAVESAÑO DE ZÓCALO

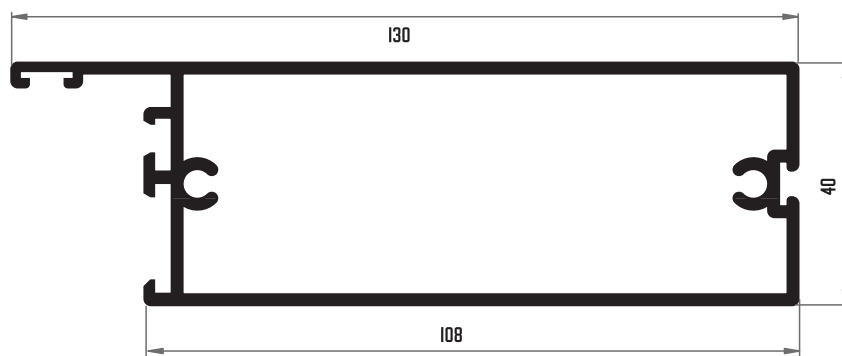

214 MARCO DE ZÓCALO

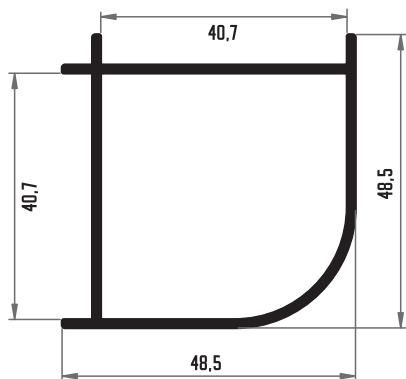

217 ESQUINERO 40 MM

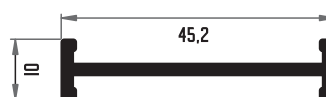

215 MAINEL CENTRAL 40 MM

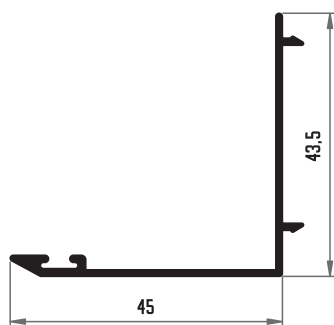

213 SOLAPE DE MARCO

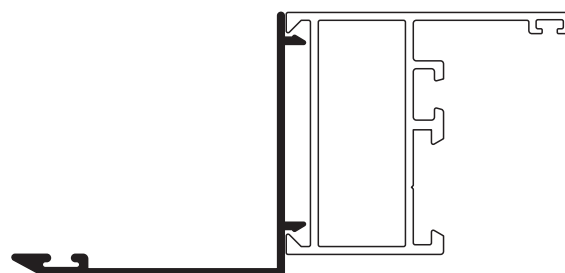

MONTAJE SOLAPE DE MARCO

\* BAJO PEDIDO



▶▶ 062 JAMBA LISA 37.9 MM ▶▶

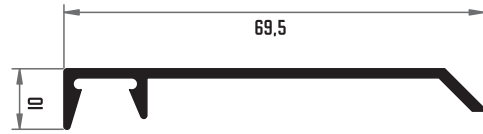

▶▶ 014 JAMBA LISA 69.5 MM ▶▶

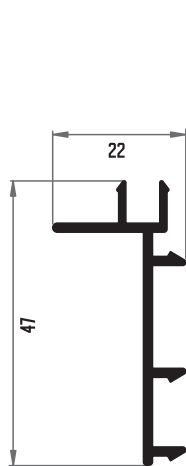

▶▶ 019 ACOUPLE PARA JAMBA LISA ▶▶

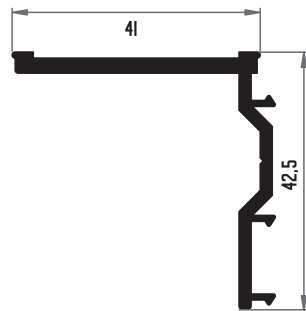

▶▶ 067 ACOUPLE JAMBA CURVA ▶▶

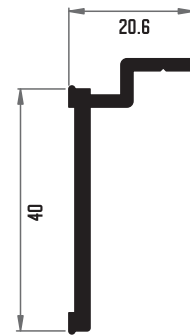

▶▶ 064 ACOUPLE DE JAMBA ▶▶

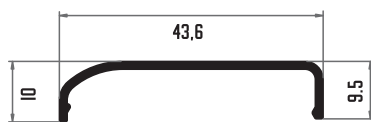

▶▶ 098 JAMBA CURVA 43 MM ▶▶

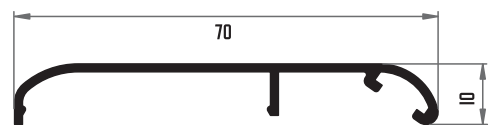

▶▶ 066 JAMBA CURVA 70 MM ▶▶

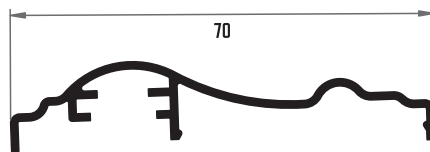

▶▶ 061 JAMBA DECORADA 70 MM ▶▶

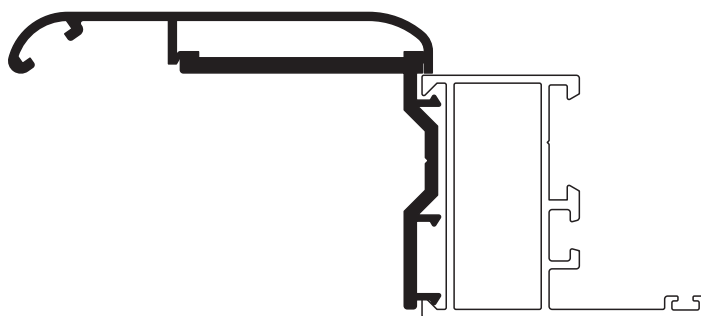

» MONTAJE JAMBA CURVA «

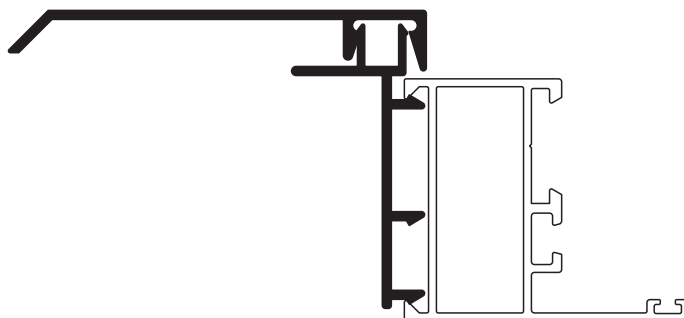

» MONTAJE JAMBA LISA «

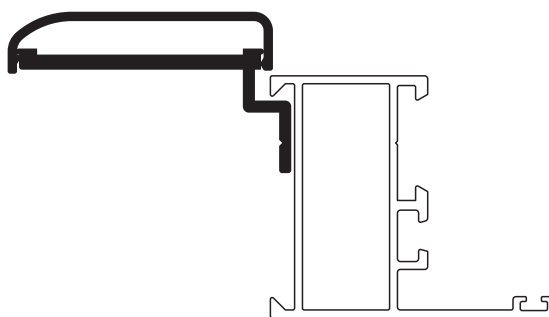

» MONTAJE JAMBA CURVA «

TIPOS					HUECO
MEDIDA	RETESTAR	GRAPA	NUDO	LISO	HUECO
4 mm					32 mm
11 mm					25 mm
13 mm					23 mm
16 mm					20 mm
21 mm					15 mm
25 mm					11 mm
28 mm					8 mm
29 mm					7 mm
33.5 mm					2.5 mm

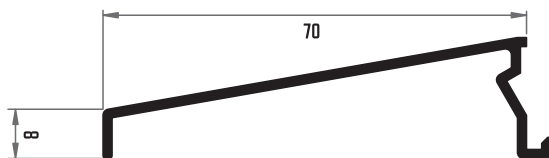

▶▶ 017 GOTERÓN 70 mm ▶▶

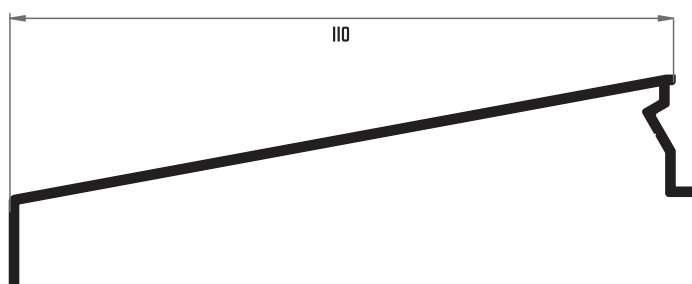

▶▶ 2770 GOTERÓN 110 mm ▶▶

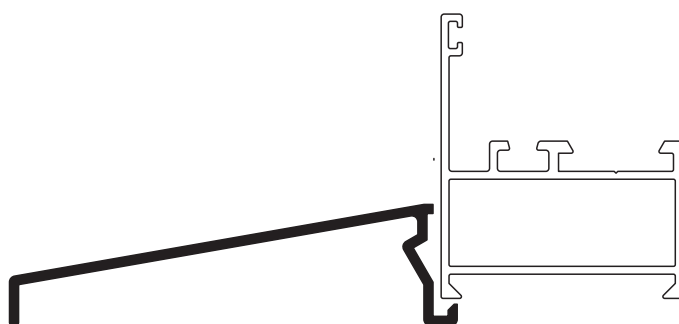

▶▶ MONTAJE GOTERÓN ▶▶



▶ ABISAGRADA DE 1 HOJA

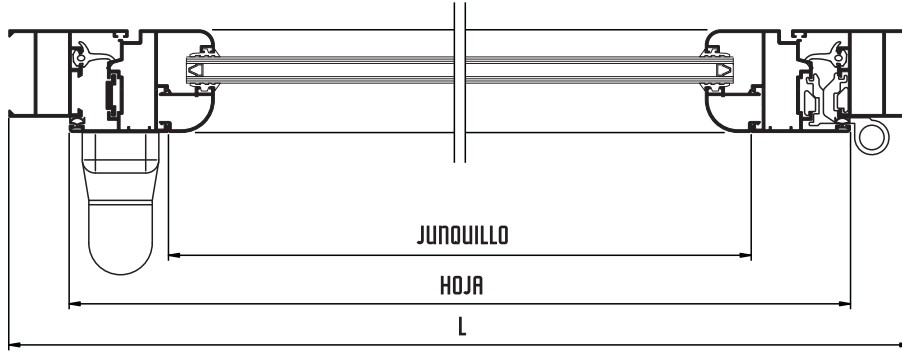

SECCIÓN A-A

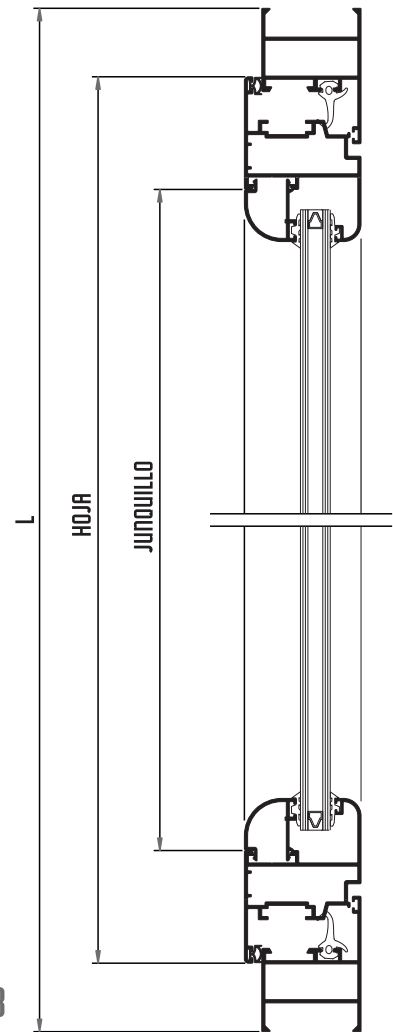
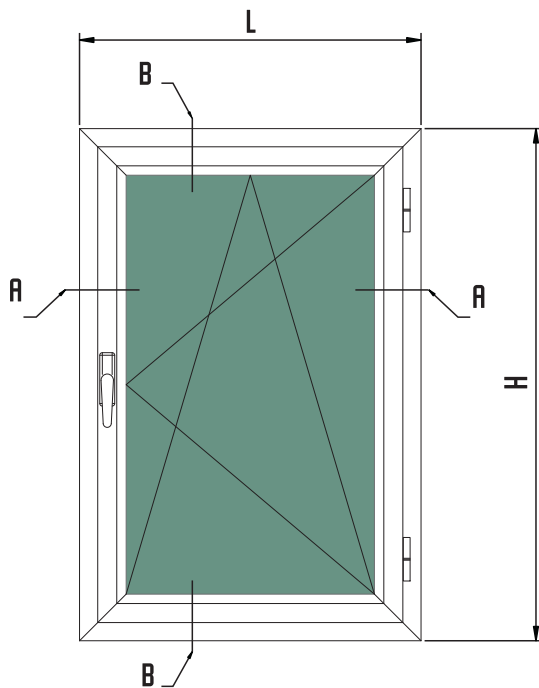

SECCIÓN B-B

CROQUIS	REFERENCIA	DENOMINACIÓN	TIPO DE CORTE	CANTIDAD	MEDIDA
	201	MARCO		2 2	L H
	204	HOJA CURVA		2 2	L-55.2 H-55.2
	030	JUNQUILLO REDONDO RETESTAR 21 MM		2 2	L-146 H-146

▶ ABISAGRADA DE 2 HOJAS

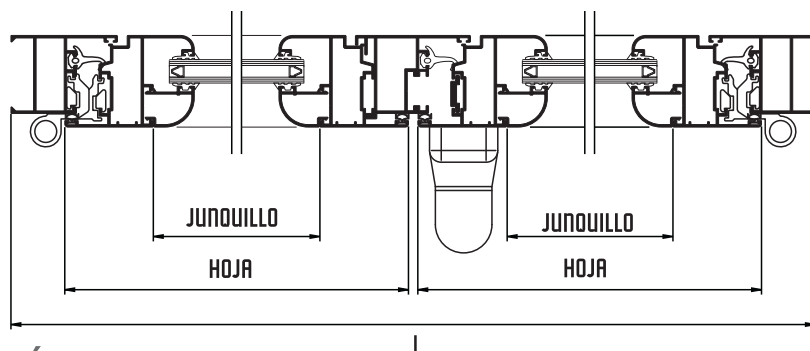

SECCIÓN A-A

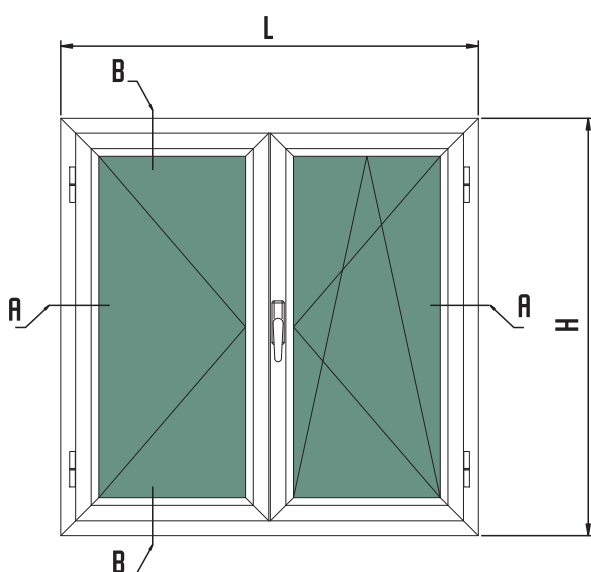

SECCIÓN B-B

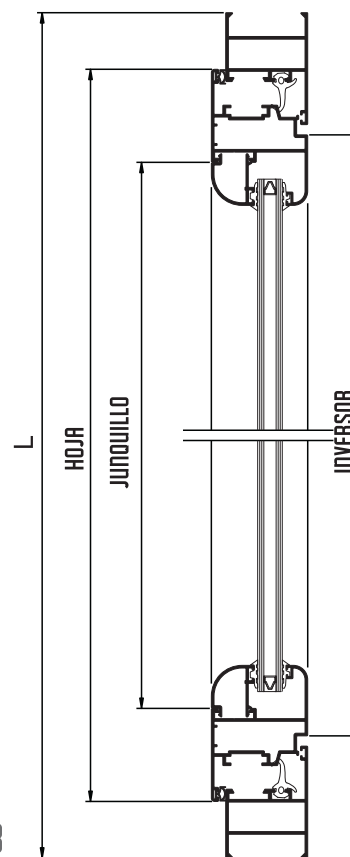

CROQUIS	REFERENCIA	DENOMINACIÓN	TIPO DE CORTE	CANTIDAD	MEDIDA
	201	MARCO		2 2	L H
	204	HOJA CURVA		4 4	L/2-30 H-55.2
	208	INVERSOR		1	H-125.2
	030	JUNQUILLO REDONDO RETESTAR 21 MM		4 4	L/2-121 H-146